

## 5A,200V Schottky Barrier Rectifier

### Features

- Low forward voltage, low power loss
- Low leakage current
- High surge current
- Plastic package has underwriters Laboratory  
Flammability Classification 94V-0
- Halogen-free according to IEC 61249-2-21

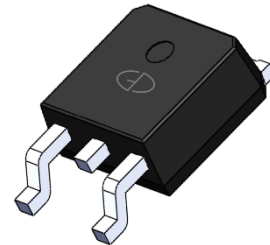

**TO-252 (D-PAK)**

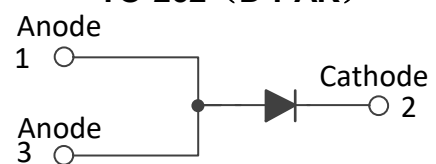

### Applications

- SMPS
- Lighting
- UPS

### Mechanical Data

- Case: Epoxy, Molded
- Finish: All External Surfaces Corrosion Resistant and Terminal Leads are Readily Solderable
- Lead Temperature for Soldering Purposes: 260°C Max. for 10 sec
- Shipped 2500 units per reel

### Maximum Ratings & Electrical Characteristics (TA=25°C unless otherwise noted)

Parameter	Symbol	MBRD5200S	Unit
Maximum repetitive peak reverse voltage	VRRM	200	V
Working peak reverse voltage	VRMS	140	V
Maximum DC blocking voltage	VDC	200	V
Maximum average forward rectified current	IF(AV)	5	A
Peak forward surge current, 8.3ms single half sine-wave superimposed on rated load per diode	IFSM	110	A
Voltage rate of change (rated VR)	dv/dt	10000	V/uS
Operating junction temperature range	TJ	-55 to +150	°C
Storage temperature range	TSTG	-55 to +150	°C

<b>Electrical Specifications</b> ( $T_A=25^{\circ}\text{C}$ unless otherwise noted)					
Parameter	Symbol	Test Conditions	Typ	Max	Unit
Forward drop voltage (Note1)	$V_F$	$I_F=5\text{A}, T_J=25^{\circ}\text{C}$	0.81	0.95	V
		$I_F=5\text{A}, T_J=125^{\circ}\text{C}$	-	0.88	
Reverse leakage current @VR (Note2)	$I_R$	$T_J=25^{\circ}\text{C}$	-	200	$\mu\text{A}$
		$T_J=100^{\circ}\text{C}$	-	15	mA

<b>Thermal-Mechanical Specifications</b> ( $T_A=25^{\circ}\text{C}$ unless otherwise noted)			
Parameter	Symbol	Typ	Unit
Thermal Resistance, Junction to Case	$R_{\theta JC}$	4	$^{\circ}\text{C}/\text{W}$
Thermal Resistance, Junction to Ambient	$R_{\theta JA}$	62.5	$^{\circ}\text{C}/\text{W}$

Note:

1. Pulse test with  $PW=0.3\text{ms}$ , duty cycle=2%
2. Pulse test with  $PW=30\text{ms}$

## Ratings and Characteristics Curves

(TA = 25°C unless otherwise noted)

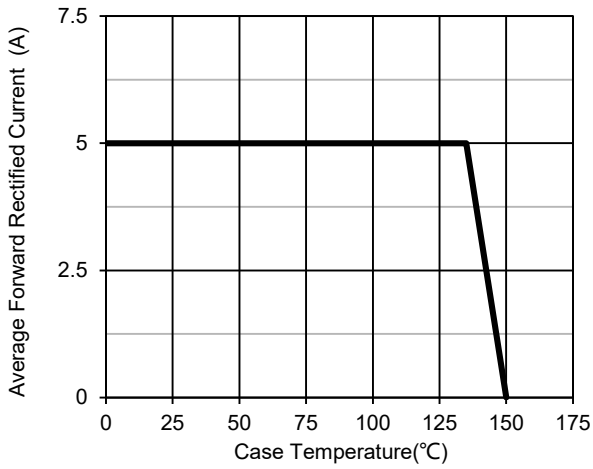

**Fig.1 – Forward Current Derating Curve**

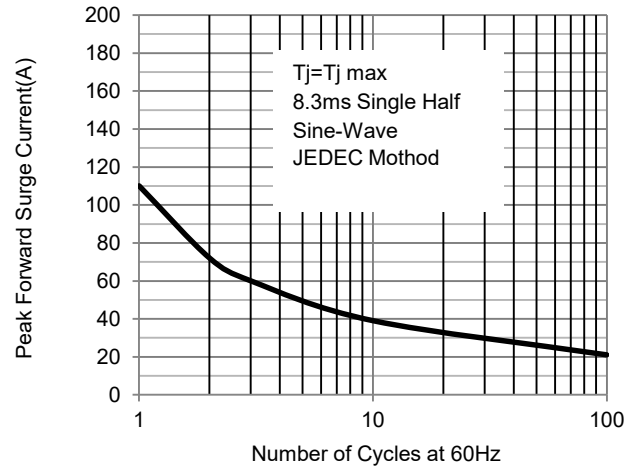

**Fig.2 – Maximum Non-Repetitive Surge Current**

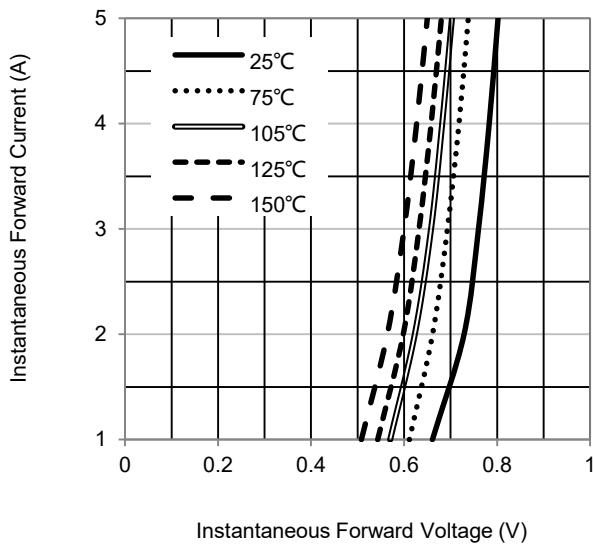

**Fig.3 – Typical Forward Voltage Characteristics**

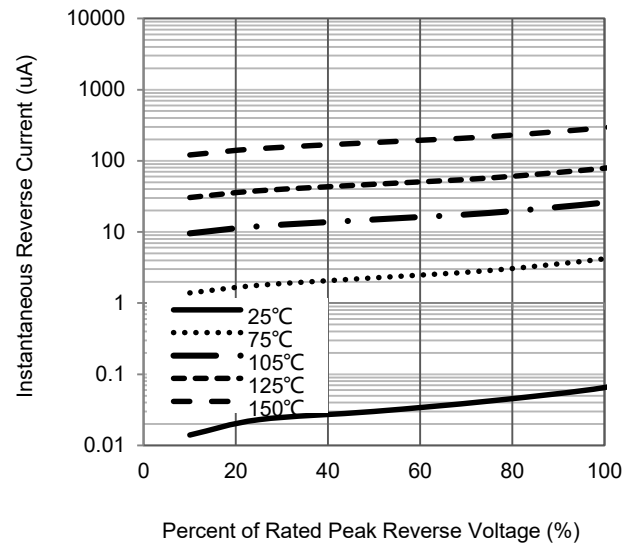

**Fig.4 – Typical Reverse Current Characteristics**

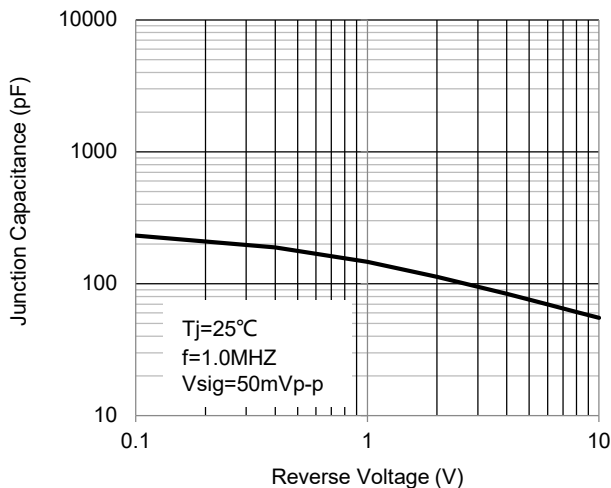

**Fig.5 – Typical Junction Capacitance**

## Package Outline Dimensions (Unit: millimeters)

### TO-252 (D-PAK)

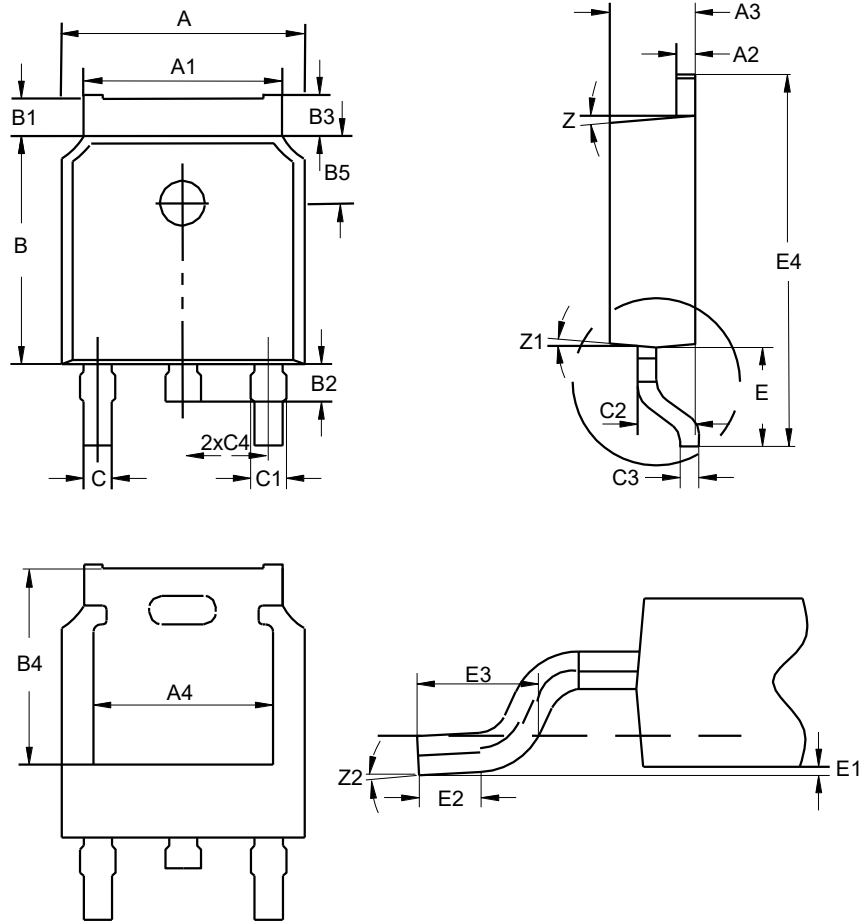

TO-252							
	Min.	Nom.	Max.		Min.	Nom.	Max.
A	6.34	6.54	6.74	C1	0.65	0.85	1.05
A1	5.1	5.3	5.5	C2	1.34	1.54	1.74
A2	0.4	0.5	0.6	C3	0.4	0.5	0.6
A3	2.08	2.28	2.48	C4	2.09	2.29	2.49
A4	4.6	4.8	5.0	E	2.6	2.9	3.2
B	5.8	6.1	6.4	E1	0		0.15
B1	0.82	1.02	1.22	E2	0.7		
B2	0.8	1	1.2	E3	1.3	1.6	1.9
B3	0.9	1.1	1.3	E4	9.8	10.1	10.4
B4	5.05	5.25	5.45	Z		7°	
B5	7.83	8.03	8.23	Z1		7°	
C	0.56	0.76	0.96	Z2	0°		10°

## Marking Outline

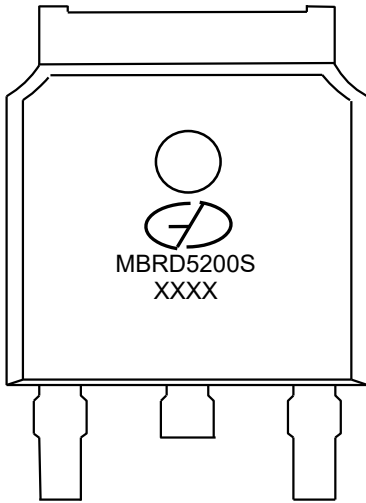

1. Logo Mark: 
2. Part Name: MBRD5200S
3. Data code: XXXX

## Revision History

Document Version	Date of release	Description of changes
Rev.A	2022.01.11	Preliminary Datasheet

## Disclaimers

These materials are intended as a reference to assist our customers in the selection of the Suzhou Good-Ark product best suited to the customer's application; they do not convey any license under any intellectual property rights, or any other rights, belonging to Suzhou Good-Ark Electronics Co., Ltd. or a third party.

Suzhou Good-Ark Electronics Co., Ltd. assumes no responsibility for any damage, or infringement of any third-party's rights, originating in the use of any product data, diagrams, charts, programs, algorithms, or circuit application examples contained in these materials.

All information contained in these materials, including product data, diagrams, charts, programs and algorithms represents information on products at the time of publication of these materials, and are subject to change by Suzhou Good-Ark Electronics Co., Ltd. without notice due to product improvements or other reasons. It is therefore recommended that customers contact Suzhou Good-Ark Electronics Co., Ltd. or an authorized Suzhou Good-Ark Electronics Co., Ltd. for the latest product information before purchasing a product listed herein. The information described here may contain technical inaccuracies or typographical errors. Suzhou Good-Ark Electronics Co., Ltd. assumes no responsibility for any damage, liability, or other loss rising from these inaccuracies or errors. Please also pay attention to information published by Suzhou Good-Ark Electronics Co., Ltd. by various means, including our website home page.

(<http://www.goodark.com>)

When using any or all of the information contained in these materials, including product data, diagrams, charts, programs, and algorithms, Please be sure to evaluate all information as a total system before making a final decision on the applicability of the information and products. Suzhou Good-Ark Electronics Co., Ltd. assumes no responsibility for any damage, liability or other loss resulting from the information contained herein.

The prior written approval of Suzhou Good-Ark Electronics Co., Ltd. is necessary to reprint or reproduce in whole or in part these materials.

Please contact Suzhou Good-Ark Electronics Co., Ltd. or an authorized distributor for further details on these materials or the products contained herein.